



DINAK FK

EINWANDIGE SCHORNSTEINE UND ABGASLEITUNGEN AUS EDELSTAHL



0036



FK

0036 CPD 90220 002

Edelstahl 1.4404

EN 1856-1

T250 P1 W V2 L50040 O(50)

Edelstahl 1.4301

EN 1856-1

T250 P1 W Vm L20040 O(50)

0036 CPD 90220 015

Edelstahl 1.4404

EN 1856-2

T600 P1 W V2 L50040 G

Edelstahl 1.4301

EN 1856-2

T600 P1 W Vm L20040 G



DINAK

DINAK DEUTSCHLAND

Wiehler Str. 5

51545 Waldbröl.

☎ +49 2291 907409 - 0

☎ +49 2291 907409 - 09

✉ deutschland@dinak.com

www.dinak.com



ISO 9001: 2000



EINWANDIGE SCHORNSTEINE UND ABGASLEITUNGEN AUS EDELSTHAL

DINAK FK



0036 CPD 90220 002

Abgasleitung Edelstahl Nr. 14404
EN 1856-1 T250 P1 W V2 L50040 O(50)
Abgasleitung Edelstahl Nr. 14301
EN 1856-1 T250 P1 W Vm L20040 O(50)

0036 CPD 90220 015

EN 1856-2: INNENROHRE
Sanierung Edelstahl Nr. 14404
EN 1856-2 T600 P1 W V2 L50040 G
Sanierung Edelstahl Nr. 14301
EN 1856-2 T600 P1 W Vm L20040 G

WERKSTOFFE

- Edelstahl Nr. 1.4404
- Edelstahl Nr. 1.4301 (auf Wunsch)

KENNZEICHNUNGEN

- Druckklasse P 1 ohne Dichtungen
Kondensationsbetriebe
Abgasleitung mit Dichtung
- Durchmesser von 80 bis 400 mm
- Einfache und Schnelle Montage
- Kürzbare Längenelemente

ANWENDUNGEN

- Trocken (D) Feucht (W)
- Über- und Unterdruck
- Ideal für die Sanierung





- 1 KONDENSATSCHALE MIT ABLAUF 265 mm
- 2 T-STÜCK 90° FÜR REINIGUNG/ANSCHLUSSTEIL
- 1 ANSCHLUSSTEIL FÜR T-STÜCK 90°
- 1 REINIGUNGSDECKEL
- 1 LÄNGENELEMENTE 925 mm mit Ablassschlaufen
- 5 LÄNGENELEMENTE 925 mm

- 2 LÄNGENELEMENTE 425 mm
- 1 ABSTANDHALTER
- 1 KOPFABDECKUNG
- 1 WETTERKRAGEN
- 1 DICHTSET
- 1 REINIGUNGSTÜR 210 mit Mauerkasten

Ø	FULL CONTACT BAUSATZ (7,0m)
80	X
100	X
110	X
130	X
150	X
180	X
200	X
250	
300	

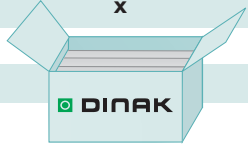

X= Verfügbarer Bausatz

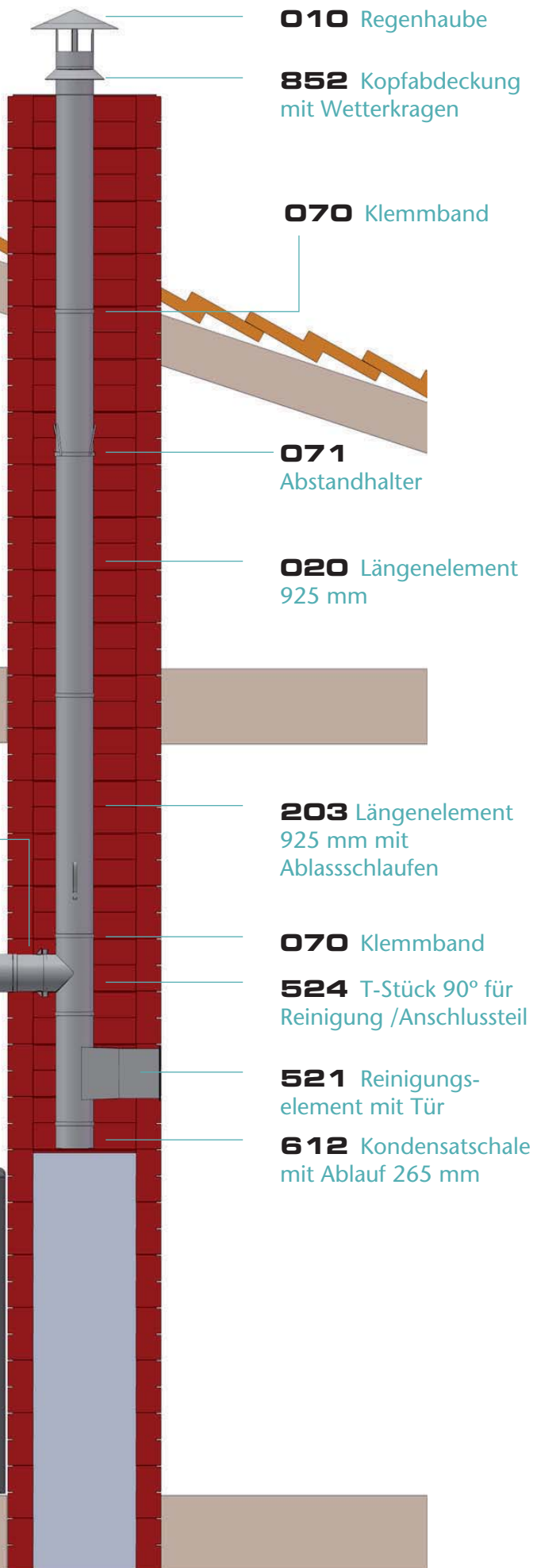

010 Regenhaube

852 Kopfabdeckung mit Wetterkragen

070 Klemmband

071 Abstandhalter

020 Längenelement 925 mm

203 Längenelement 925 mm mit Ablassschlaufen

070 Klemmband

524 T-Stück 90° für Reinigung /Anschluss

521 Reinigungselement mit Tür

612 Kondensatschale mit Ablauf 265 mm

317 Anschlussstück für T-Stück 90°

025 Längenelement 260 mm

432 Inspektionswinkel

024 Längenelement 425 mm

LÄNGENELEMENTE



020
Längenelement
925 mm



023
Schiebeelement
350-530 mm

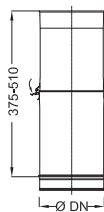

203
Längenelement
925 mm mit
Ablausschlaufen

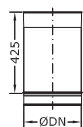

024
Längenelement
425 mm

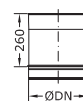

025
Längenelement
260 mm

KLEMMBÄNDER

070
Klemmband

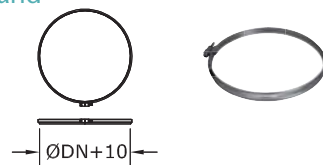

703
Klemmband für Dichtung

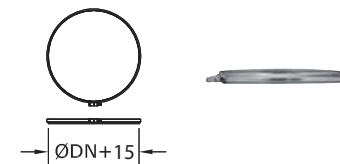

003
Dichtung

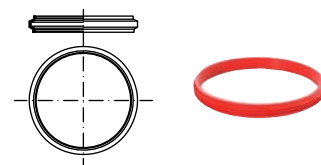

WINKEL

044 Winkel 15°

Ø mm	80	100	110	130	150	180	200	250	300	350	400
A mm	45	45	45	50	50	50	55	55	60	65	65
A1 mm	110	110	110	115	115	115	120	120	125	130	130

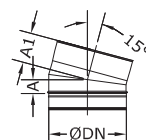

042 Winkel 30°

Ø mm	80	100	110	130	150	180	200	250	300	350	400
A mm	50	55	55	60	60	65	65	75	80	85	95
A1 mm	115	120	120	125	125	130	130	140	145	150	160

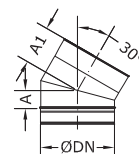

040 Winkel 45°

Ø mm	80	100	110	130	150	180	200	250	300	350	400
A mm	55	60	60	65	65	80	80	90	100	110	120
A1 mm	120	125	125	130	130	145	145	155	170	180	180

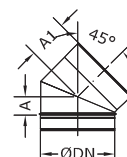

043 Winkel 87°

Ø mm	80	100	110	130	150	180	200	250	300	350	400
A mm	135	150	155	170	175	175	175	200	220	250	280
A1 mm	185	200	205	215	225	225	225	250	280	310	340

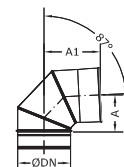

433 Winkel 90°

Ø mm	80	100	110	130	150	180	200	250	300	350	400
A mm	125	140	145	160	170	170	170	200	210	250	280
A1 mm	185	200	205	220	230	230	230	260	270	310	340

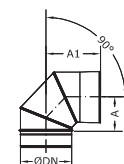

431 Inspektionswinkel 87°

Ø mm	80	100	110	130	150	180	200	250	300	350	400
A mm	135	150	155	170	180	175	180	200	220	250	280
A1 mm	185	200	205	215	230	225	225	250	280	310	340

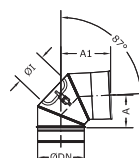

WINKEL

432 Inspektionswinkel 90°

∅ mm	80	100	110	130	150	180	200	250	300	350	400
A mm	135	140	145	160	170	165	170	200	210	250	280
A1 mm	185	200	205	220	230	225	260	260	270	310	340

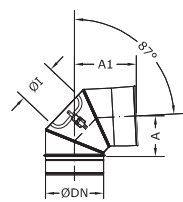

T-STÜCKE

031 T-Stück 90°

31A T-Stück 87°

∅ mm	80	100	110	130	150	180	200	250	300	350	400
B mm	260	260	260	260	425	425	425	425	595	595	595
C mm	160	160	160	160	245	245	245	245	330	330	330
D mm	65	75	80	90	100	115	125	150	175	200	225

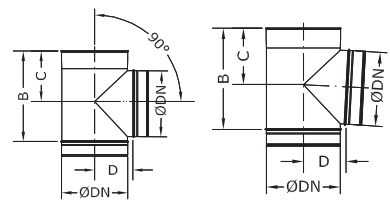

370 T-Stück 87° mit Abzweig 80mm

∅ mm	100	110	130	150	180	200	250	300	350	400	B(r)	C(r)
dh mm	80	80	80	80	80	80	80	80	80	80	260	160
D mm	80	85	95	105	120	130	155	180	205	230		

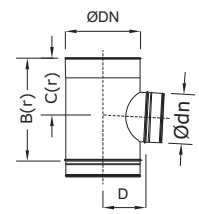

31B T-Stück 87° mit reduzierten Abzweig

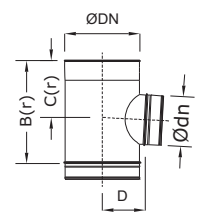

∅ mm	100	110	130	150	180	200	250	300	350	400	B(r)	C(r)	
	80	80	80	80	80	80	80	80	80	80	260	160	
			100	100	100	100	100	100	100	100	260	160	
				130	130	130	130	130	310	130	130	260	160
					150	150	150	150	150	150	150	425	245
						180	180	180	180	180	180	425	245
							200	200	200	200	200	425	245
									250	250	250	425	245
D	80	85	95	105	120	130	155	180	205	230			

T-STÜCKE / ANSCHLUSSELEMENTE

524 T-Stück 90° für Reinigung / Anschluss teil

∅ mm	80	100	110	130	150	180	200	250	300	350	400
B mm	325	325	325	325	325	325	325	325	325	325	325
C mm	195	195	195	195	195	195	195	195	195	195	195
D2 mm	70	80	85	95	105	120	130	155	180	205	230
Ø1 mm	80	100	110	130	150	150	150	150	150	150	150

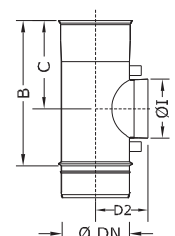

T-STÜCKE / ANSCHLUSSELEMENTE

602 Reinigungsdeckel für T-Stück 90° für Druckdichtheit

Ø mm	80	100	110	130	150	180	200	250	300	350	400
Ø1 mm	80	100	110	130	150	150	150	150	150	150	150



317 Anschlussstück für T-Stück 90°

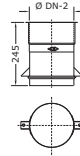

REINIGUNGEN / PRÜFELEMENTE

523 Reinigungs T-Stück mit Deckel für Druckdichtheit

Ø mm	80	100	110	130	150	180	200	250	300	350	400
B mm	260	260	260	260	425	425	425	425	595	595	595
C mm	160	160	160	160	245	245	245	245	330	330	330
D3 mm	145	155	160	170	180	195	205	230	255	280	305

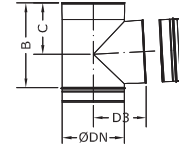

521 Reinigungselement mit Tür

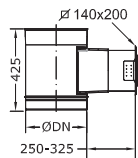

050 Element mit Messöffnung 260 mm

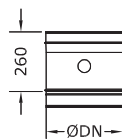

051 Element mit Messöffnung und Kondensatablauf 260 mm

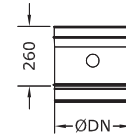

STÜTZBAUTEILE

434 Winkel 87° mit Stützfuss

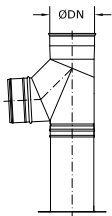

060 Verschlussdeckel

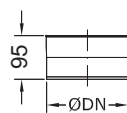

061 Kondensatschale

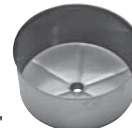
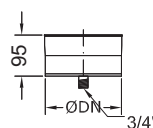

612 Kondensatschale mit Ablauf 265 mm

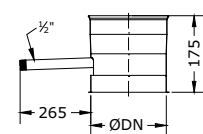

VERBINDUNGEN

026 Reduzierung / Erweiterung

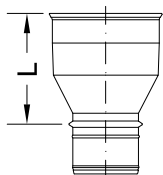

1C0 Kesselanschlussstück eingesteckt

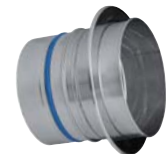
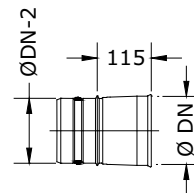

105 Verbindungskupplung FK/DW

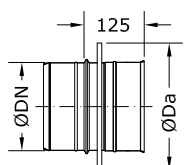

106 Verbindungskupplung DW/FK

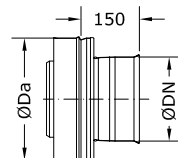

DACHABDECKUNG

852 Kopfabdeckung mit Wetterkragen

Ø mm	80	100	110	130	150	180	200	250	300	350	400
L mm	330	330	330	420	420	500	500	550	650	690	690

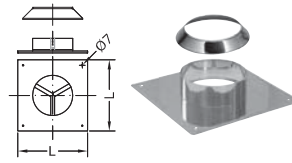

85C Dichtset



MÜNDUNGEN

010 Regenhaube

Ø mm	80	100	110	130	150	180	200	250	300	350	400
M mm	180	230	250	290	320	350	390	490	590	680	770
H mm	145	175	220	240	230	275	300	360	420	465	515

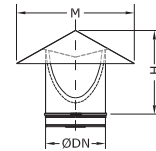

012 Wind- und Regenhaube

Ø mm	80	100	110	130	150	180	200	250	300	350	400
M mm	180	230	250	290	320	350	390	490	590	680	770
H mm	145	175	220	240	230	275	300	360	420	465	515

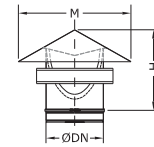

HALTERUNGEN

086 Wandbefestigungsband

Ø mm	80	100	110	130	150	180	200	250	300	350	400
R mm	30	30	30	30	30	35	35	40	20	25	35
S mm	115	135	145	165	185	220	240	295	325	380	440
T mm	60	60	60	60	60	120	120	120	120	190	190

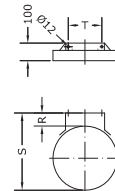

831 Wandbefestigungsband mit Verlängerung 70-120 mm

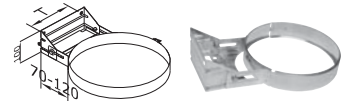

836 Verstellbares Wandbefestigungsband kurz (100-250 mm)

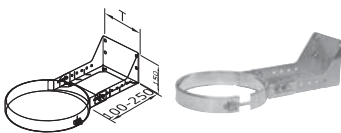

846 Verstellbares Wandbefestigungsband lang (250-430 mm)

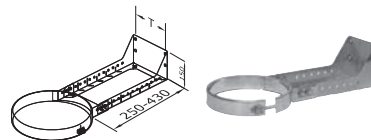

110 Abspannschelle

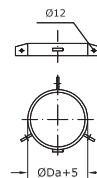

071 Abstandhalter

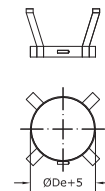

ZUBEHÖR

604 Hinterlüftungsgitter

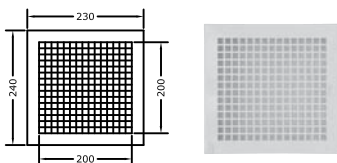

603 Reinigungstür 210 mit Mauerkasten

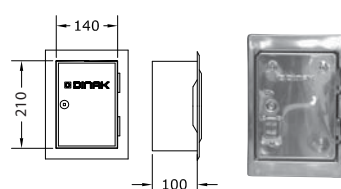

605 Reinigungstür 250 mit Mauerkasten

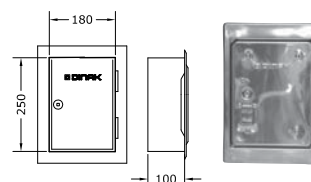

607 Reinigungstür 210 mit Mauerkasten und Schiebestutzen

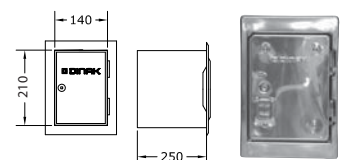

MONTAGEBEISPIELE

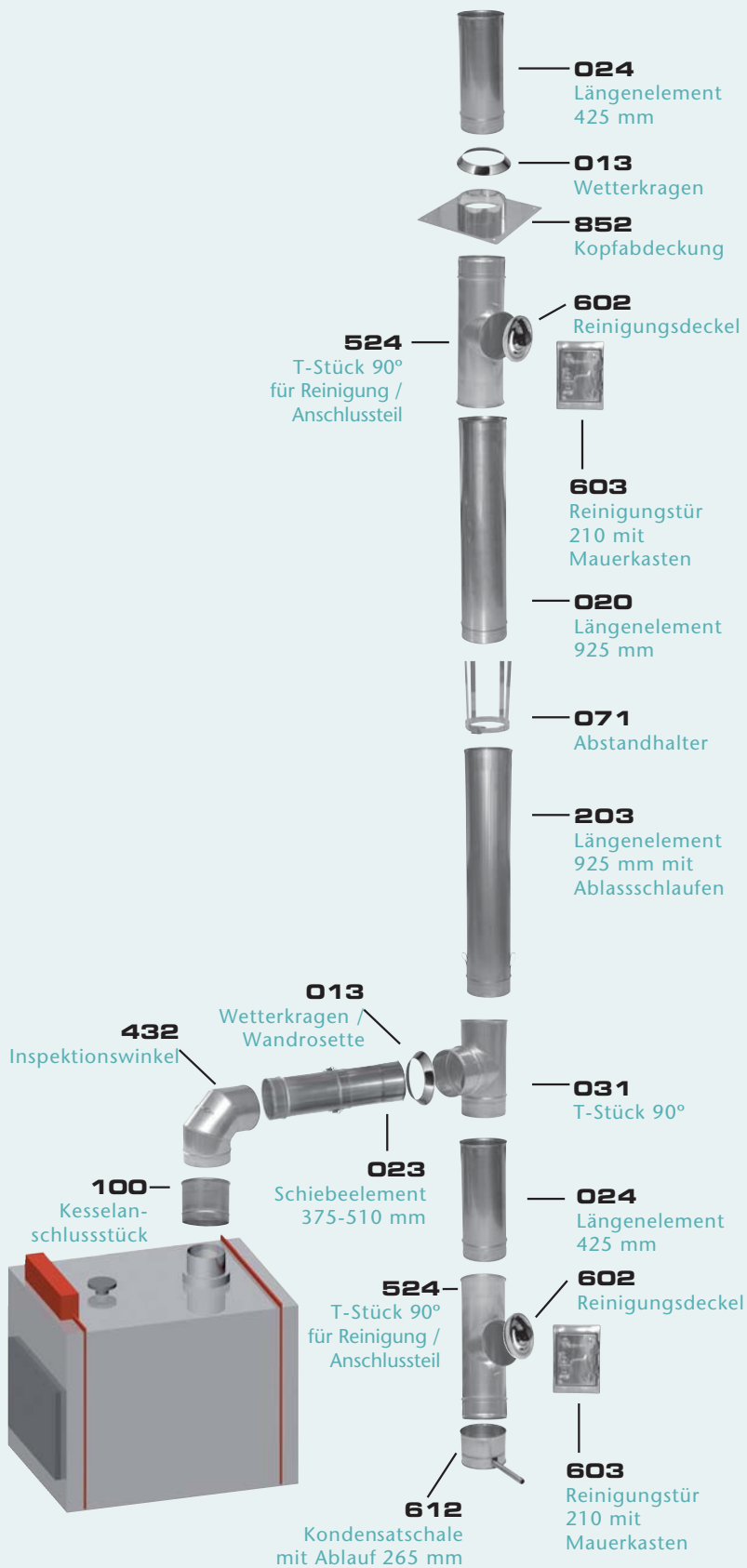

DINAK DEUTSCHLAND

Wiehler Str. 5

51545 Waldbröl.

☎ +49 2291 907409 - 0

☎ +49 2291 907409 - 09

✉ deutschland@dinak.com

DINAK S.A.

Camiño do Laranxo, 19

36216 VIGO.

☎ +34 986 452 526

☎ +34 986 454 192

✉ sales@dinak.com

www.dinak.com

